



# Hudson

## Low Bunk Bed

### Assembly Instructions

## **IMPORTANT: Please Read Carefully and Retain for Future Reference**

- High beds and the upper bed of a bunk bed is not suitable for children under six years due to the risk of injury from falling.
- High beds and Bunk beds can present a serious risk of injury from strangulation if not used correctly. Never attach or hang items to any part of the bunk bed that are not designed to be used with the bed, for example but not limited to: ropes, strings, cords, hooks, belts and bags.
- Children can become trapped between the bed and the wall, a roof pitch, the ceiling, adjoining pieces of furniture and the like. To avoid risk of serious injury the distance between the top safety barrier and any adjoining structure should not exceed 75mm or be more than 230mm.
- Do not use the bed if any structural part is broken or missing.
- Always use the tools indicated on the assembly leaflet and follow the manufacturer's instructions.
- Please regularly check that all assembly fastenings are properly tightened.
- The recommended size of the mattress (es) is 190 x 90cm.
- Please pay attention to the maximum mattress thickness which is 16cm for high beds and upper bunks but may be less for trundle drawers.
- The use of water or sleep flotation mattresses is prohibited.
- Ventilation of the room is necessary to keep the humidity low and to prevent mould in and around the bed.
- Do not place the bed near a heat source such as electrical heating, gas heating etc. to avoid any fire hazard.
- Never clean your bed with abrasive cleaners or strong detergents. Clean ONLY by wiping with a damp cloth and drying with a soft cloth.
- Conforms to the European Standard EN 747-1:2012 + A1:2015

## **Advice and Tips:**



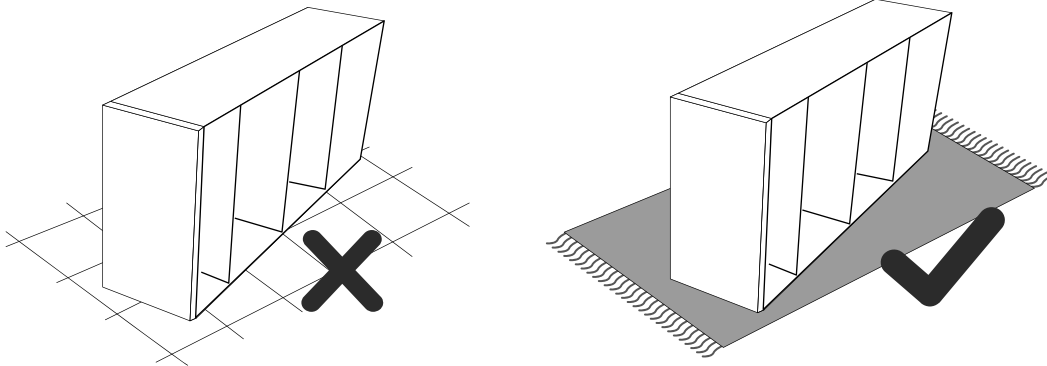

- Before you start, please read instructions carefully and retain for future use.
- Please dispose of packing materials carefully and respectfully. Keep plastic bags away from small children. Ensure small children are kept clear during assembly as this pack contains small parts.
- Build the item on a protected surface and avoid contact with hard flooring to limit damages which may occur during installation.



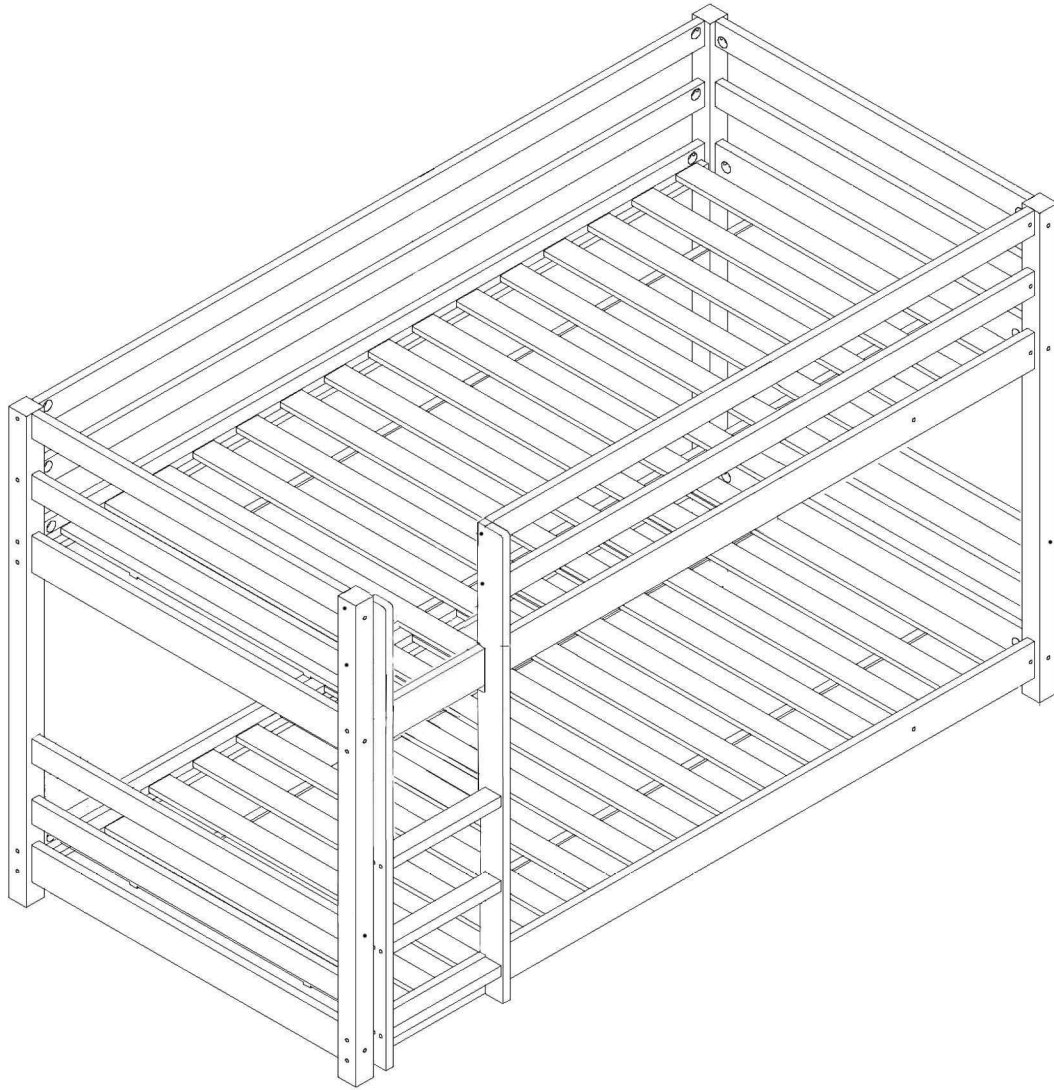

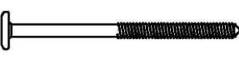



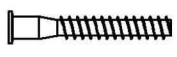





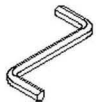

- Bouncing on or using this bed in a manner other than its intended purpose could damage the frame or cause serious injury to your child.
- Use of a night light may provide added safety precaution for a child using the upper bunk.
- If it is necessary to move the bed once installed, we advise that you avoid pushing the bed into place as this may weaken the bed and result in damage and breakages. The bed should be carefully lifted by 2 or more strong people into its final position.

# Assembly Instruction



<b>A</b>	X38	<b>B</b>	X40	<b>C</b>	X54	<b>D</b>	X12
							
M6×90mm		M6		Ø8x30mm		Ø7×60mm	





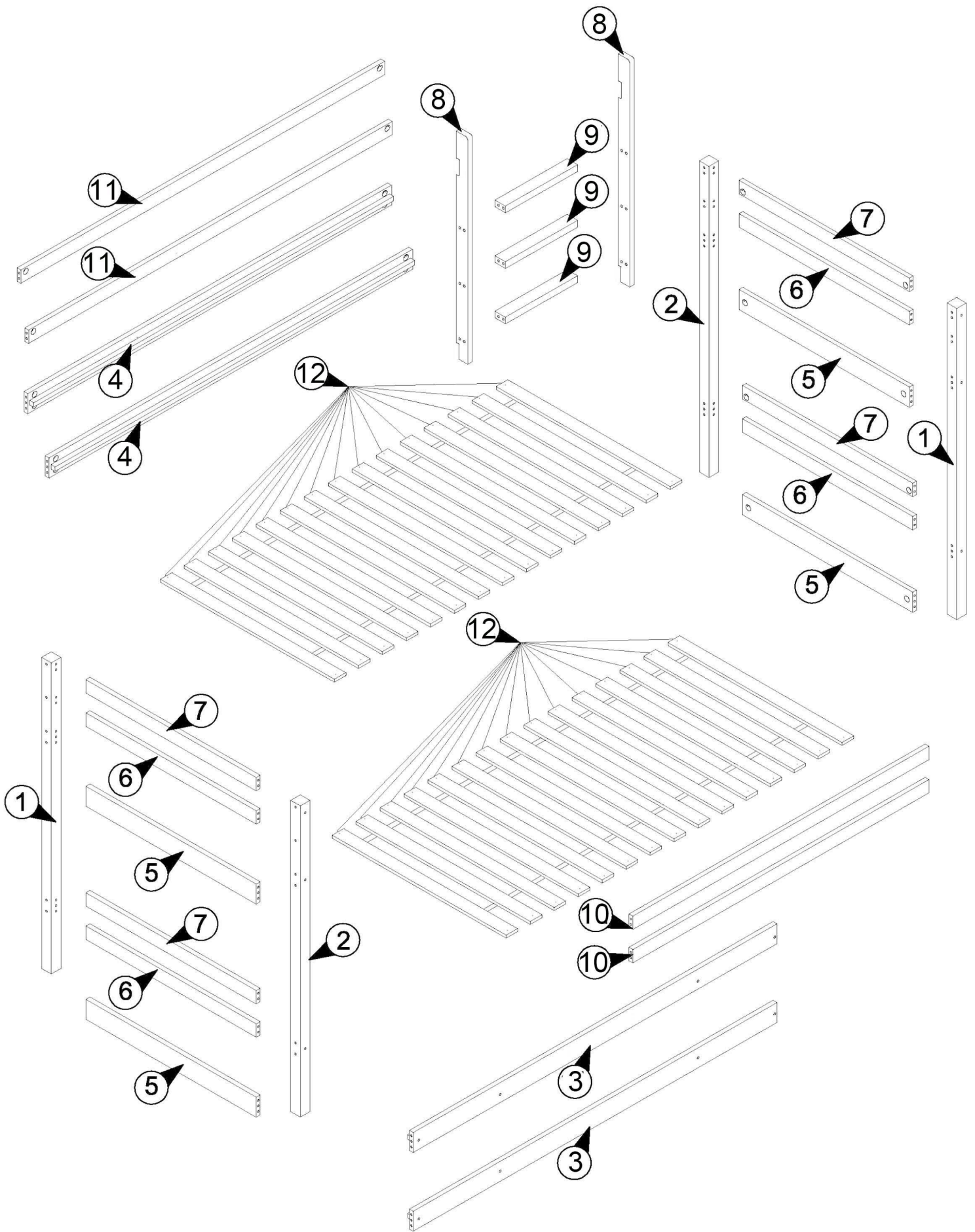

<b>E</b>	X60	<b>F</b>	X08	<b>G</b>	X40	<b>H</b>	X01
							
Ø4x30mm		M8		M15		M4	

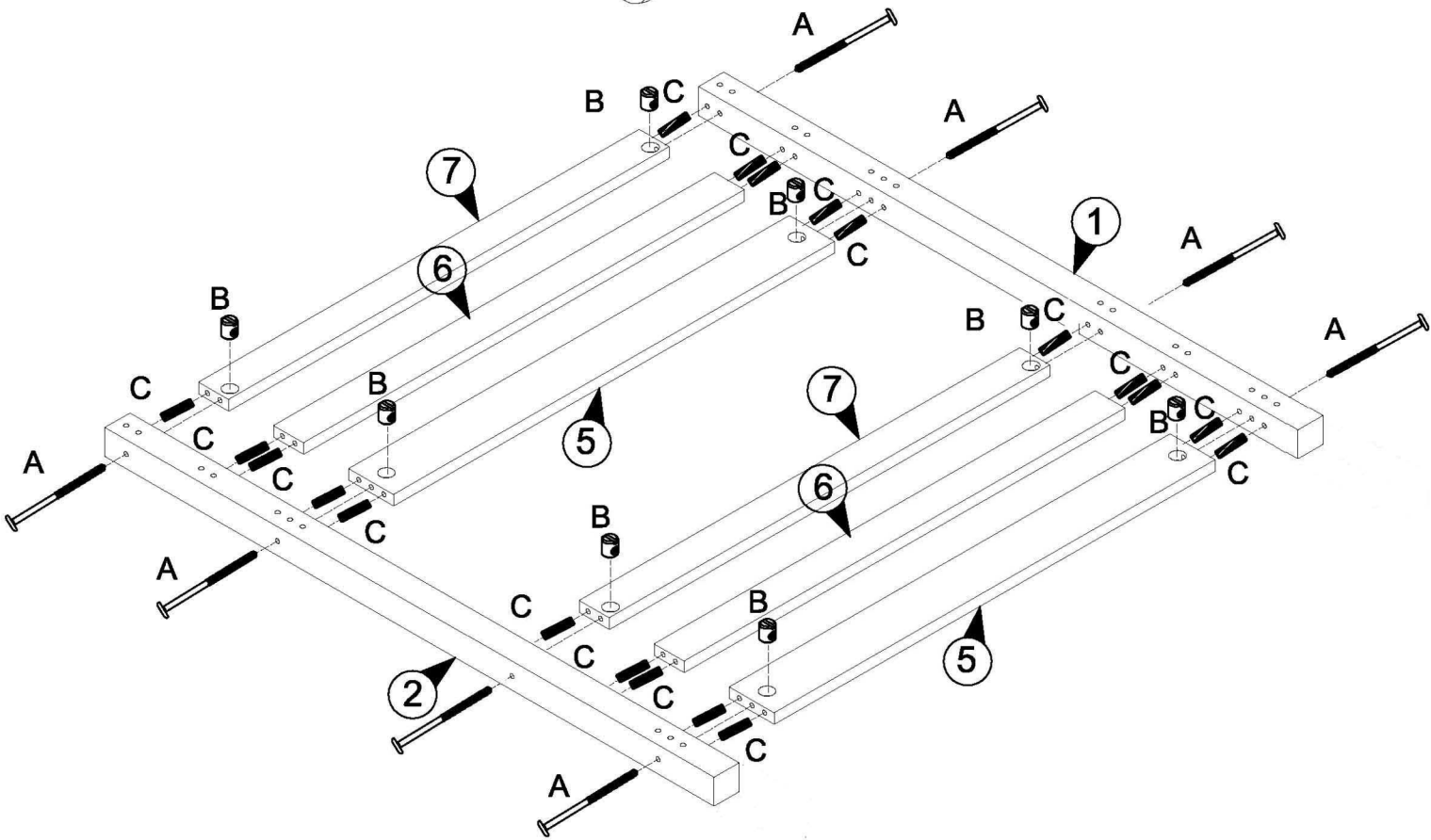
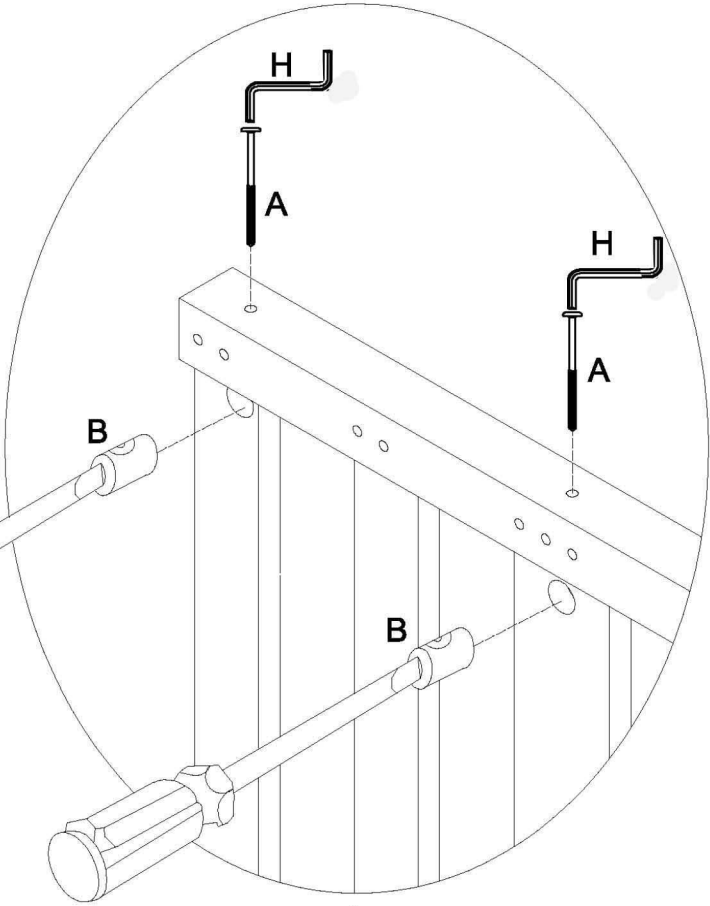
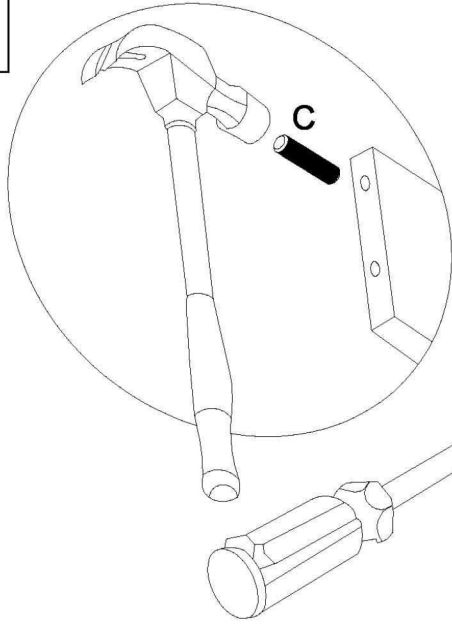
<b>I</b>	X02	<b>J</b>	X06	<b>K</b>	X06	<b>L</b>	X02
							 
M6×60mm		M6×70mm		15mm M8x20mm		Ø4x30mm	





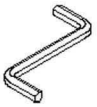
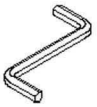

# 1

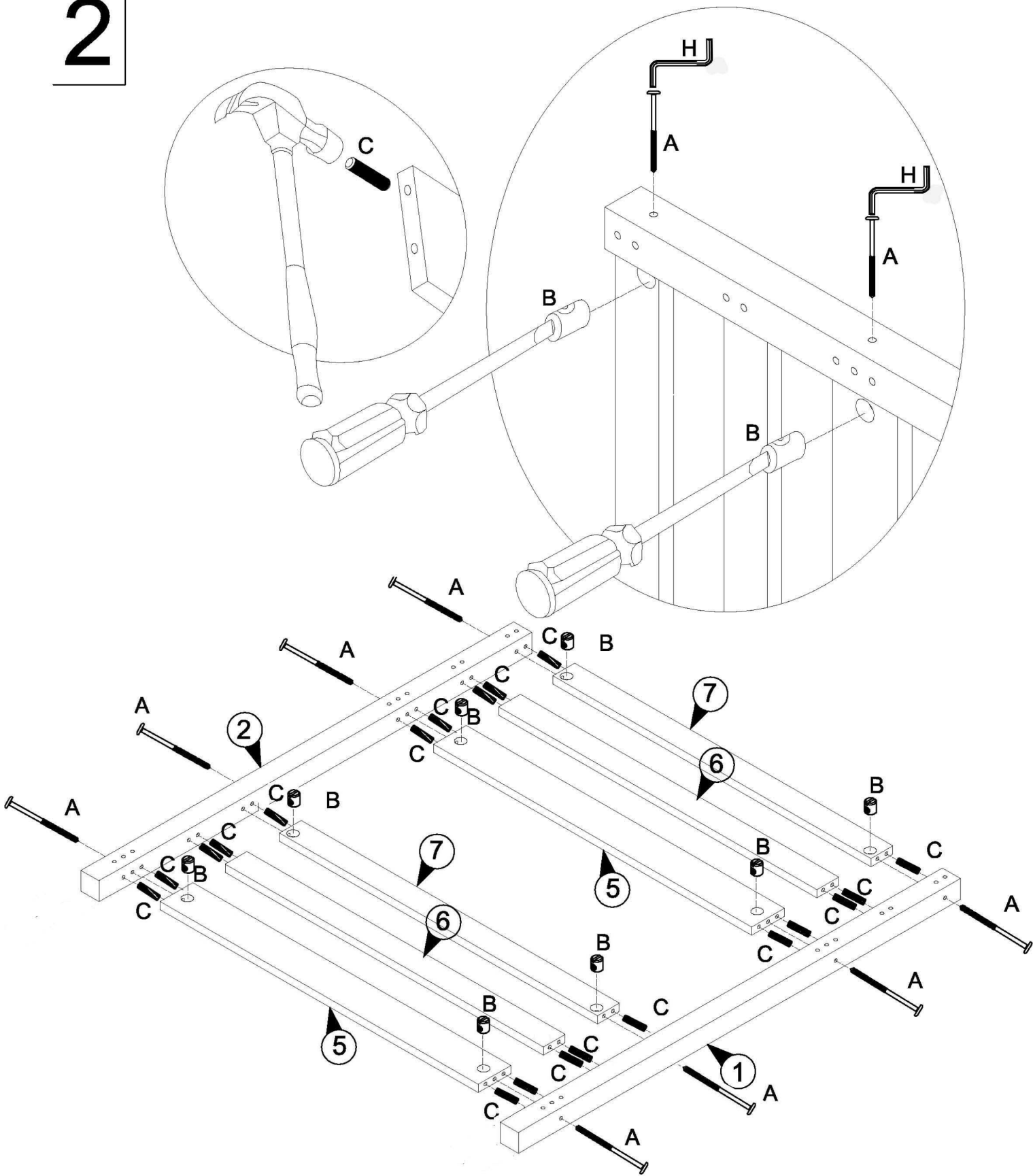

A	X08	B	X08	C	X20	H	X01
							
M6×90mm		M6		Ø8x30mm		M4	





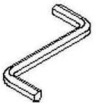

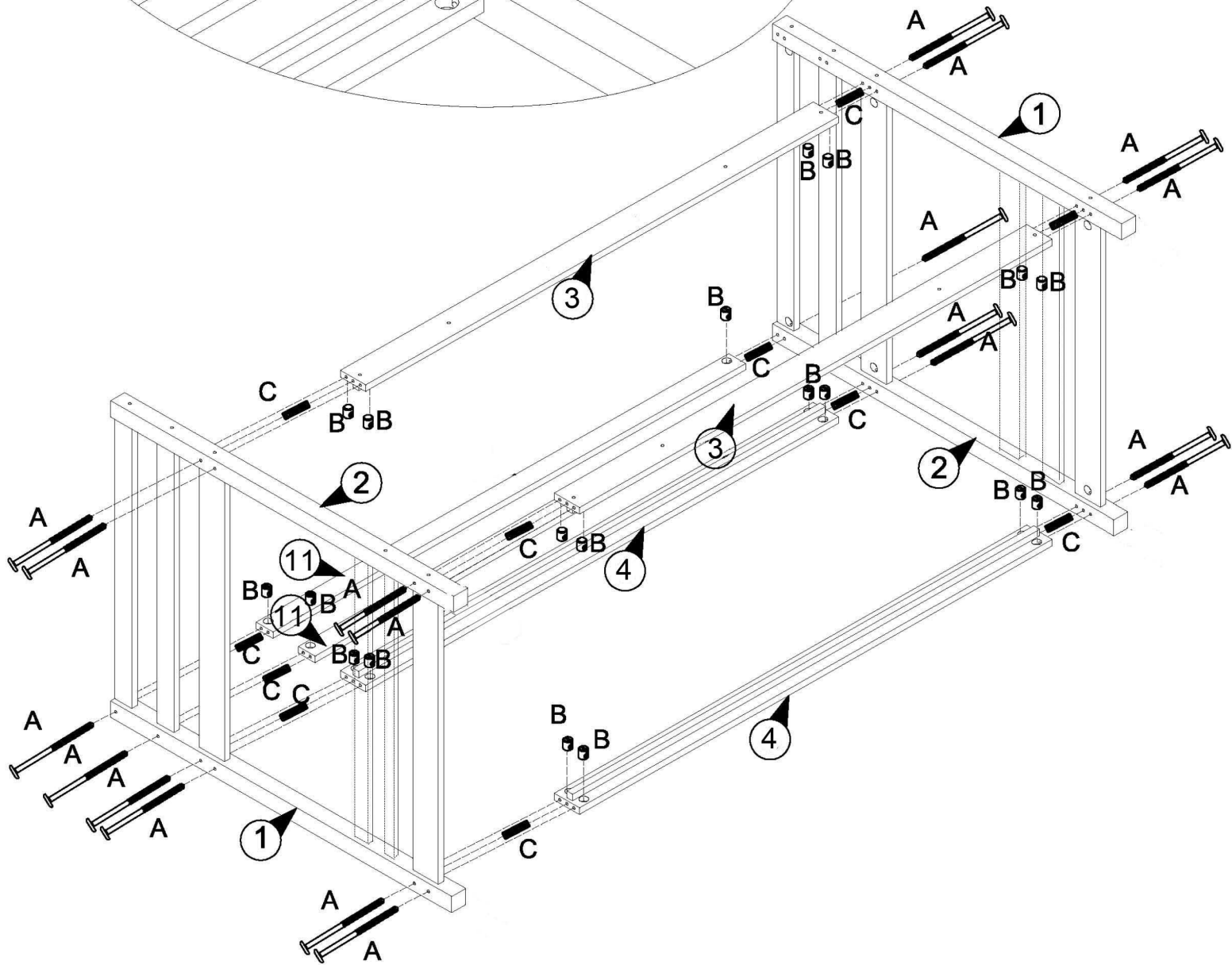
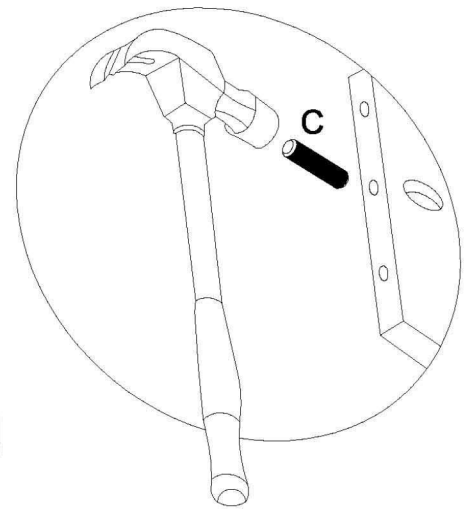
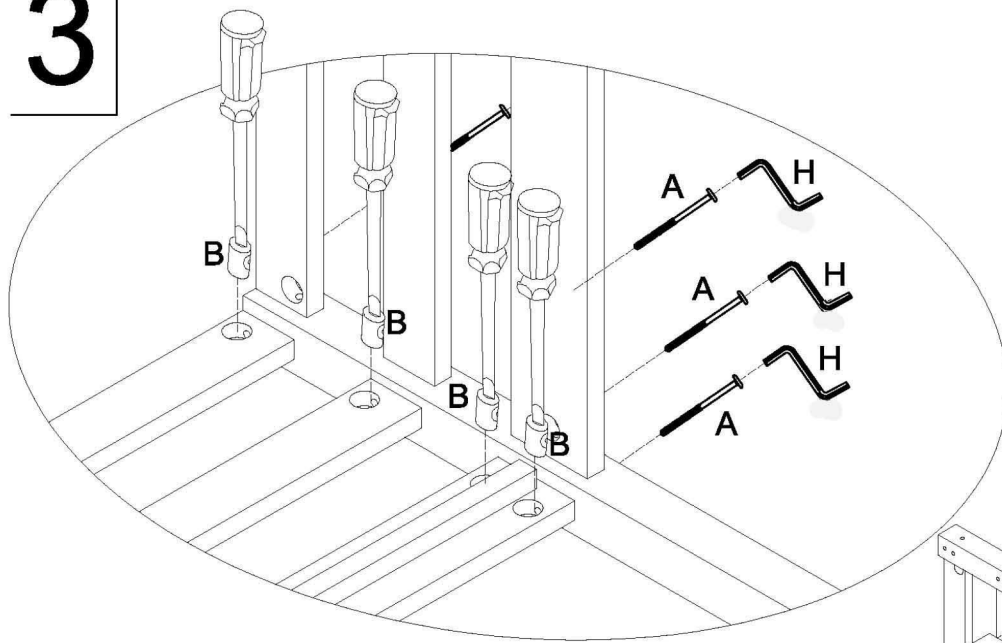

# 2



A	X08	B	X08	C	X20	H	X01
							
M6×90mm		M6		Ø8x30mm		M4	

# 3

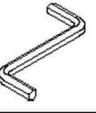





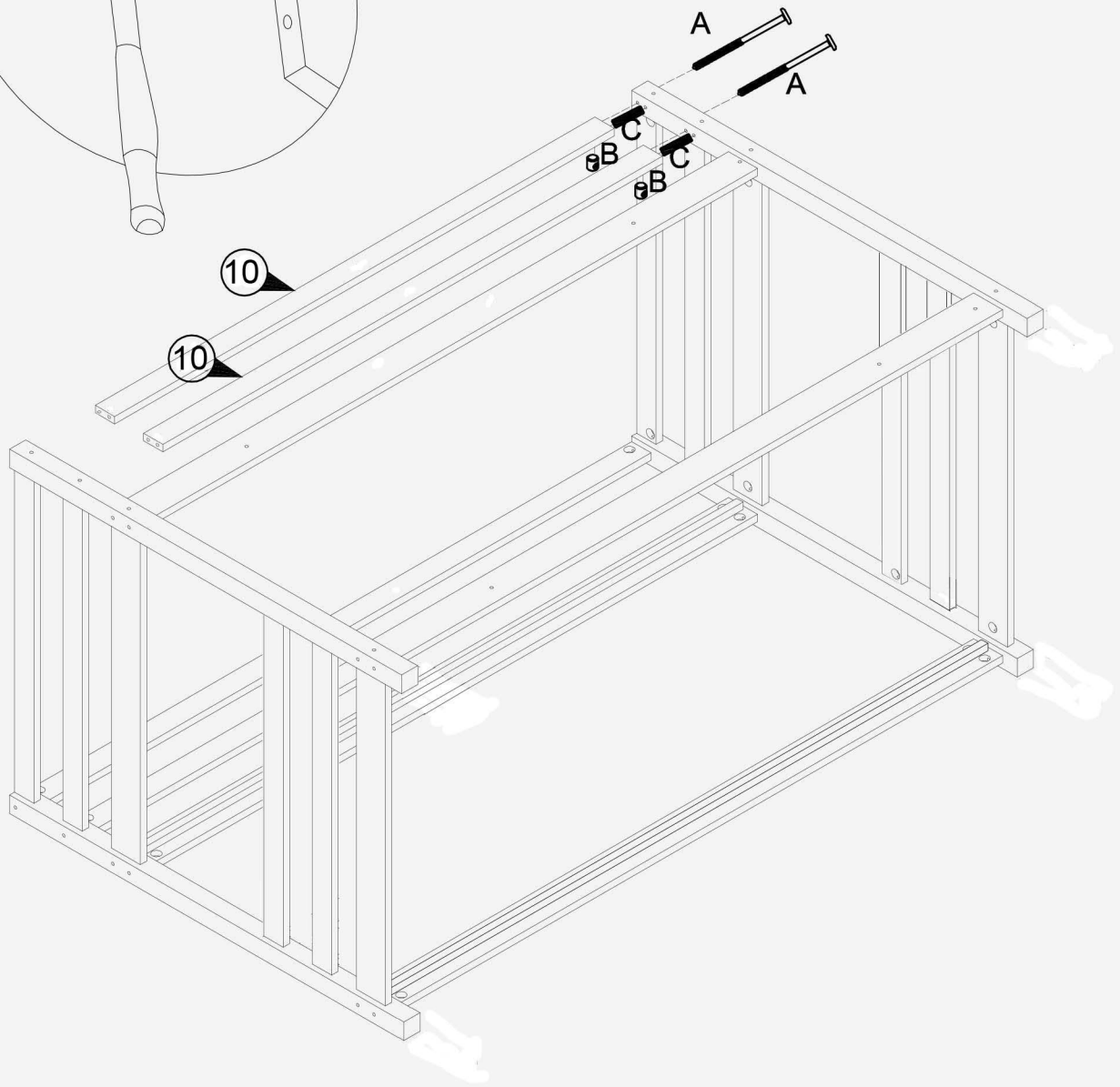
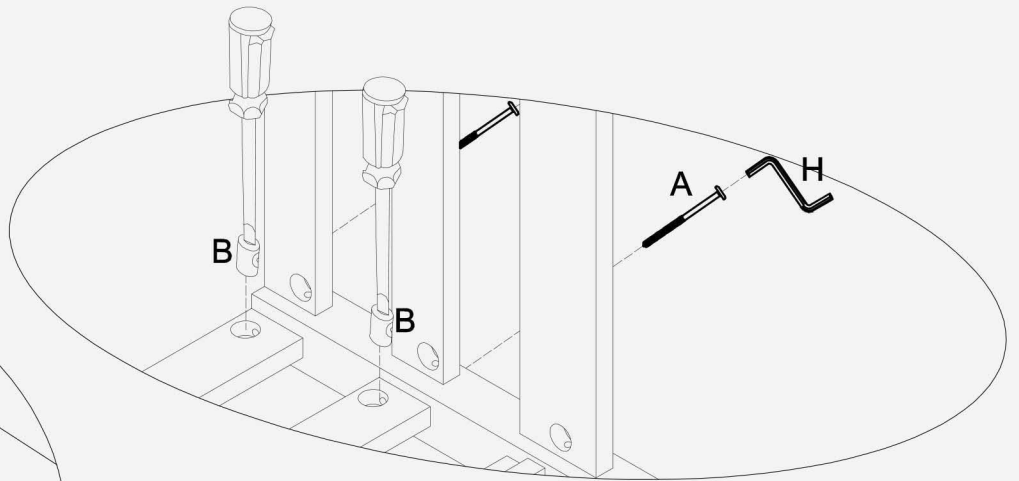
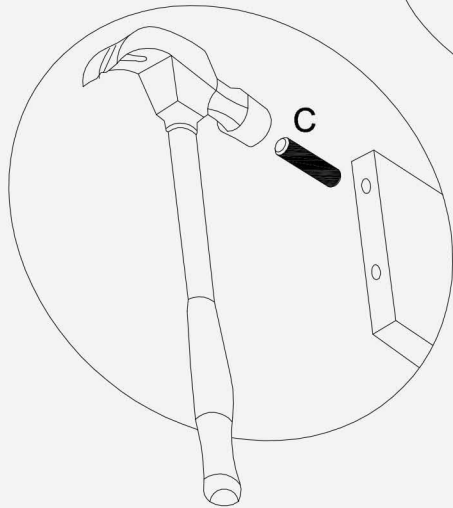

A	X20	B	X20	C	X12	H	X01
							
M6×90mm		M6		Ø8x30mm		M4	

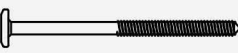



# 4



A	X02	B	X02	C	X02	H	X01
							
M6×90mm		M6		Ø8x30mm		M4	

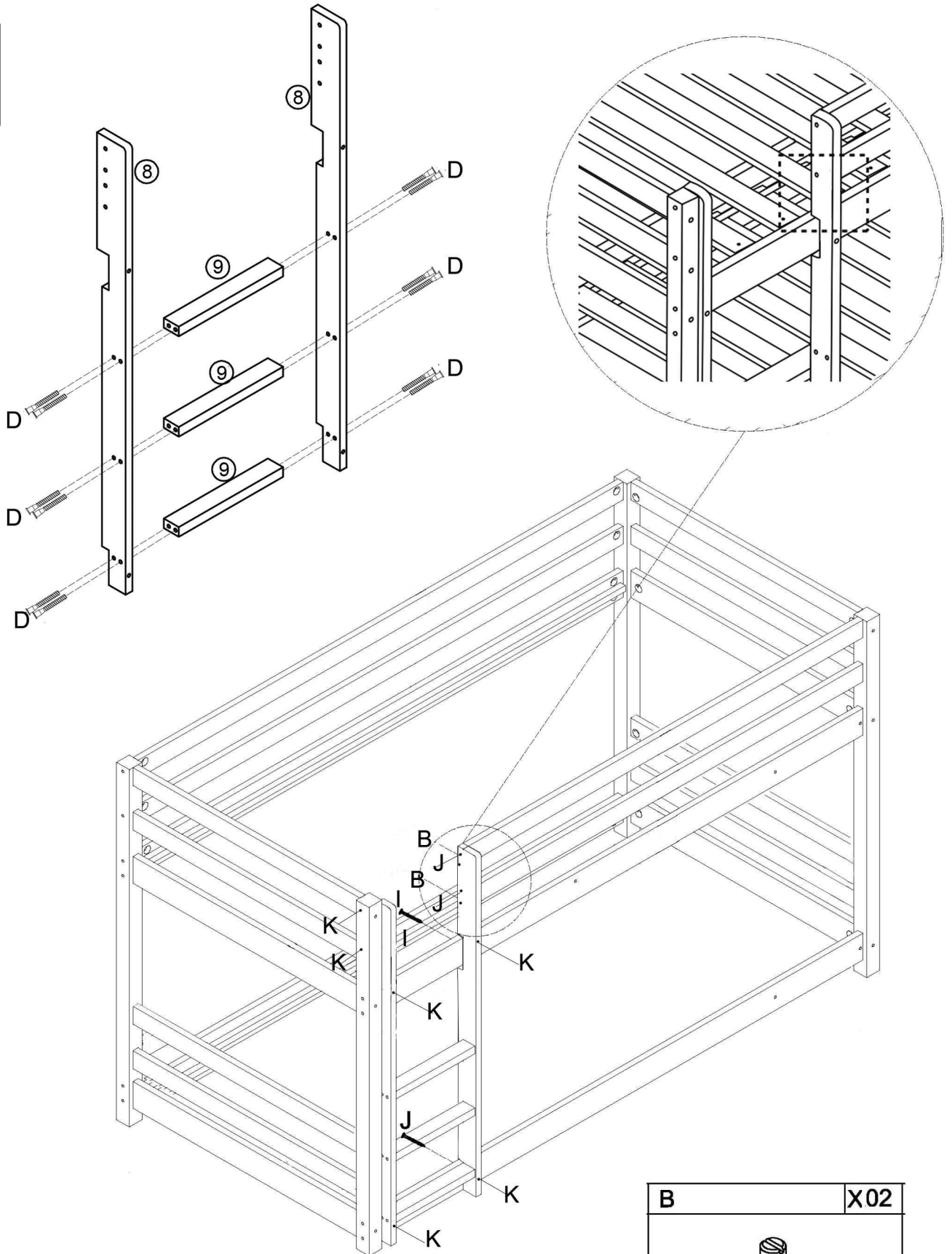

# 5

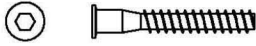
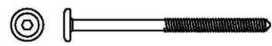
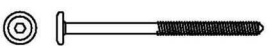
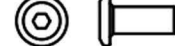

B	X02
	
M6	

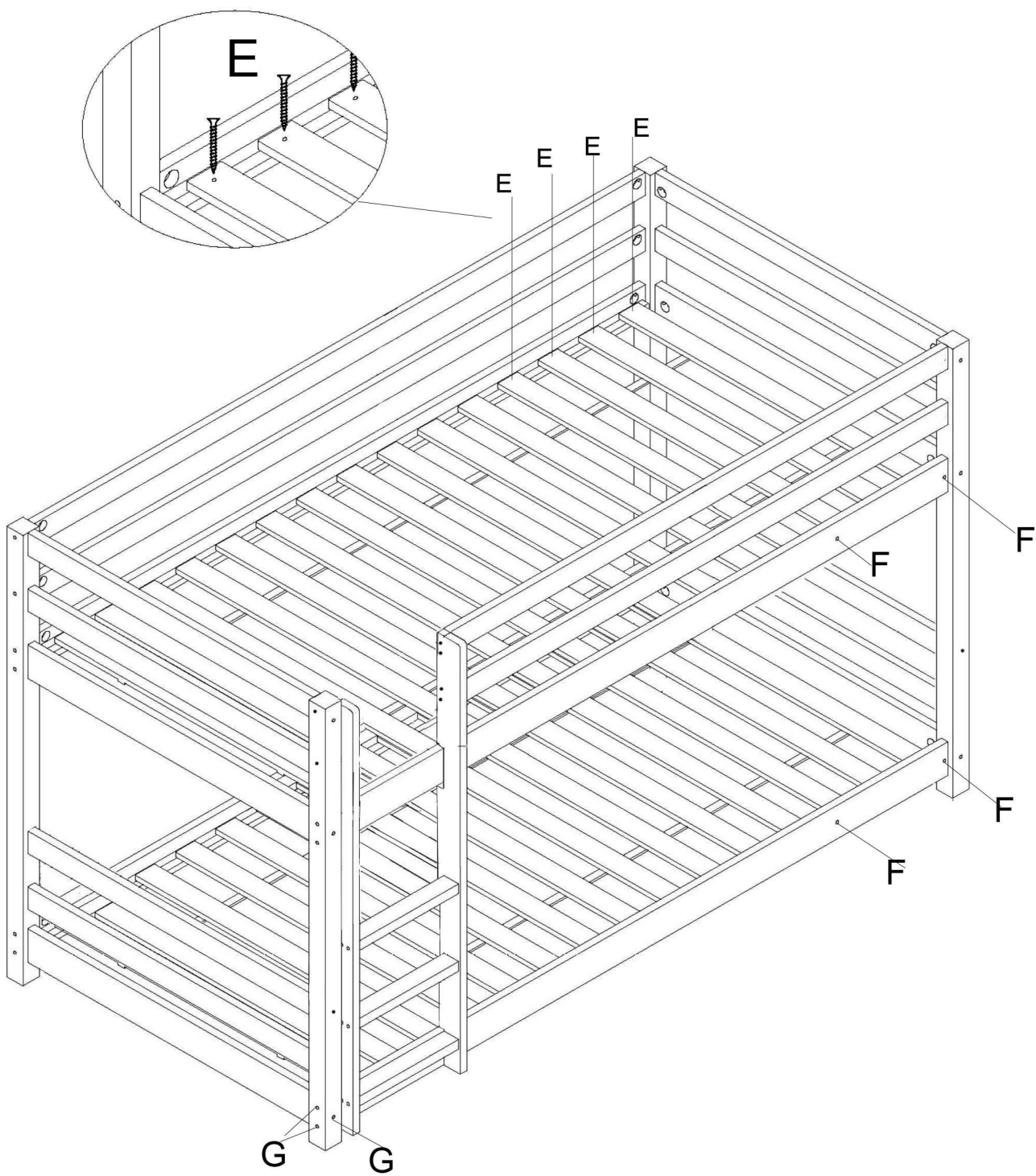
D	X12	J	X06	I	X02	K	X06
							
Ø7×60mm		M6×70mm		M6×60mm		15mm M8x20mm	

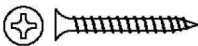

E	X60	F	X08	G	X40
					
Ø4x30mm		M8		M15	

7

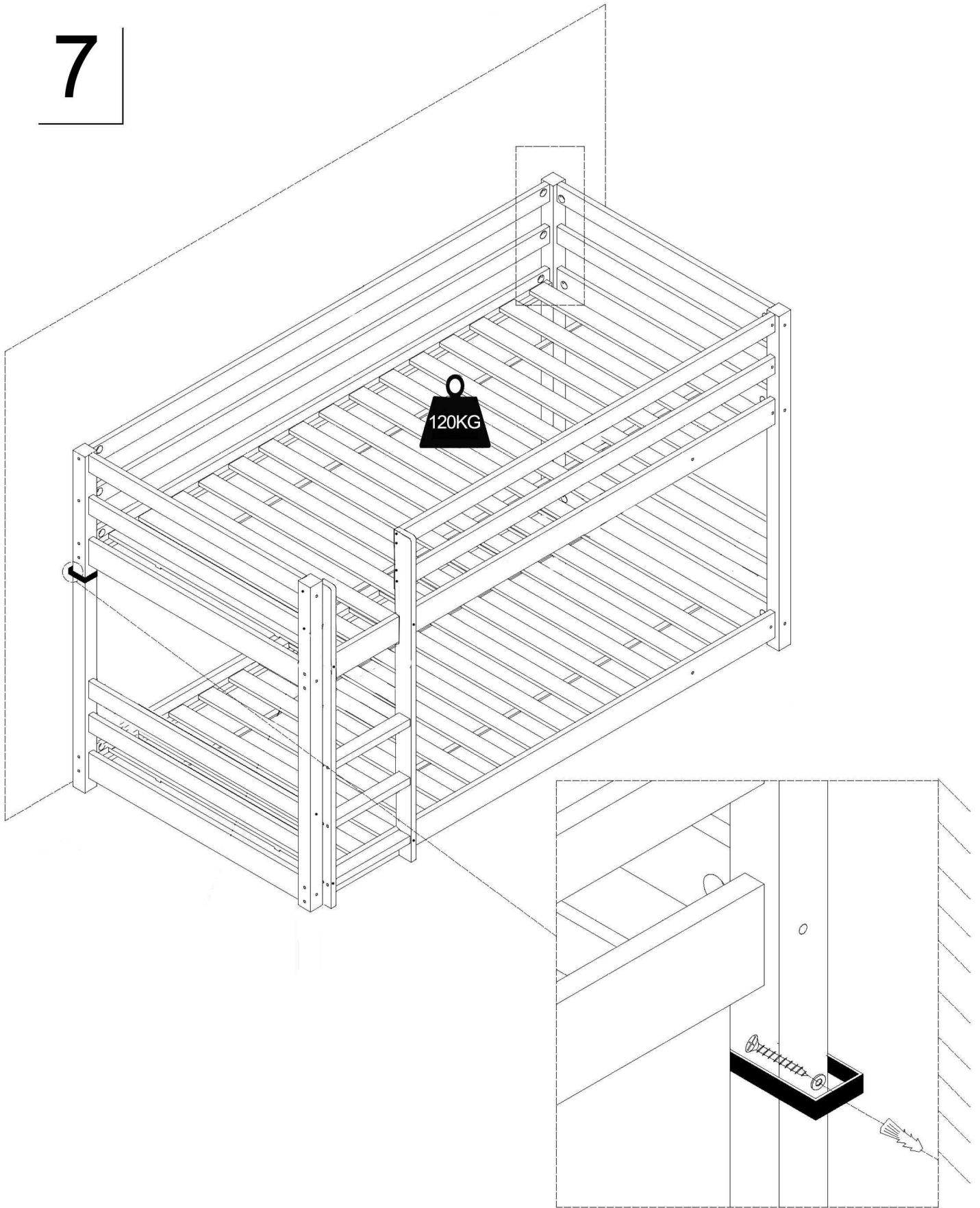

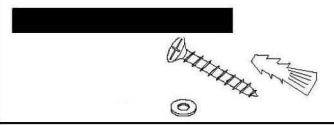
L	X02
	
Ø4x50mm	

# Warning:

**Do not place this child's bed near heat sources, windows and other furniture.**

**Do not use this child's bed if any part is broken, torn or missing.**

**Not suitable for children under 6 years.**

A: The child's bed conforms to EN 747-1/2: 2012 + A1: 2015 - Bunk beds and high beds.

B: COMPANY NAME: Cuckooland

C: ITEM NO.: B12118/B12126/B1213

D: Not suitable for children under 6 years.

E: The size of mattress: 1900x900MM. Maximum thickness: 130MM.

F: The bed is designed to be dismantled for storage and transportation.

G: All assembly fittings should always be tightened properly and checked periodically.

H: That children are likely to play, bounce, jump and climb on beds, therefore the child's bed should not be placed too close to other furniture or windows. blind cords, curtain pulls or other strings or cords, and should be placed either tight to any wall or have a gap of 300 mm between the wall and the side of the bed;

I: any additional or replacement parts are obtained from the manufacturer or distributor.